



LOCKERS™

MANUFACTURING any design. any material. any technology.

STEEL
PRODUCT CATALOG

2025

INNOVATIVE STORAGE SOLUTIONS

Offering reliability and style that stand the test of time.

662-338-4340
WWW.LOCKERSMFG.COM

INTRODUCTION.

Welcome to the Future of Storage - Solutions Tailored for Every Space!

At Lockers Manufacturing, our mission is to ensure reliability at every step of your national locker program. We are committed to providing customers with a consistently dependable buying experience, aiming to establish ourselves as the foremost locker brand in America. At the core of our company lies a dedication to reliability, demonstrated through our unwavering commitment to quality, trust, performance, consistency, dependability, accuracy, and results.

How do we achieve this? Through our reliable team, advanced technologies, effective marketing strategies, a focused and relevant product line, and efficient distribution channels.



SINCE 2014

INDEX.

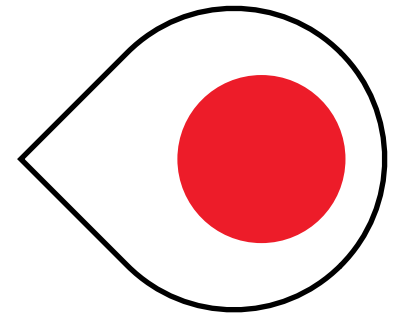

INTRODUCTION **03**

VALUE CHAIN **04**

GOING GREEN **06**

ADA **07**

LOCKERS BY INDUSTRY **08**

REQUIREMENTS & CHECKLIST **09**

WARRANTY **10**

TIER OPENINGS & HINGES **11**

HANDLES & VENTILATION **12**

LOCKERS **13**

LOCKER ACCESSORIES **27**

LOCKERS MANUFACTURING **37**

VALUE CHAIN.

Our Value Offering

- 01 FOCUS**
Customer Experience
- 02 INNOVATION**
Cutting Edge & Willing
- 03 TECHNOLOGIES**
Consistent Commitment

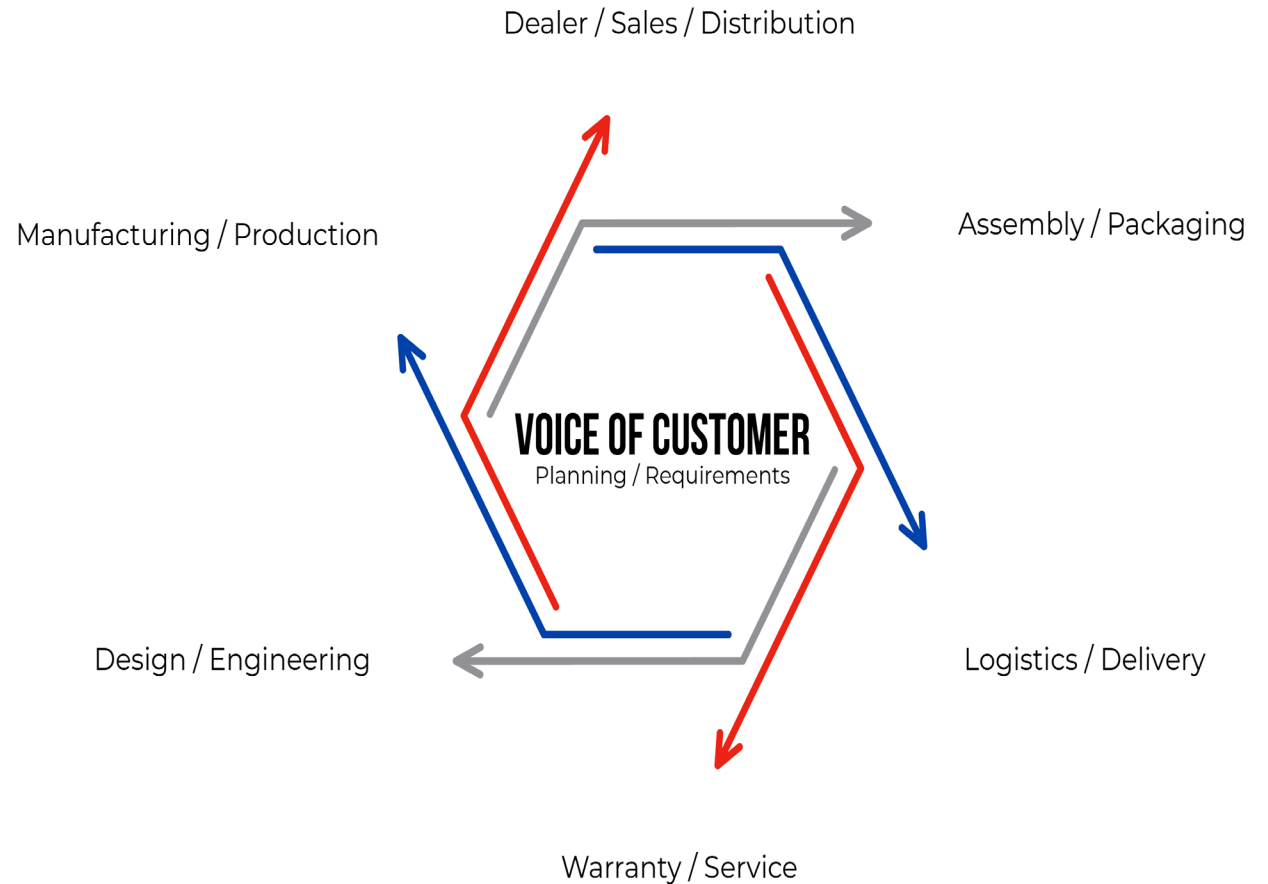

Fortune 500, US Government, Architects, Designers, Construction Professionals, Nationwide Dealer Program, Owners & Facility Managers have come to rely on Lockers



OPERATIONAL EXCELLENCE

At Lockers Manufacturing, we prioritize excellence across all aspects of our operations, ensuring a seamless and dependable buying experience for our customers. With our industry-leading Total Quality Management (TQM) and Customer Relationship Management (CRM) systems, we guarantee satisfaction at every step of the journey.

SUPPLY CHAIN EXECUTION

Nestled in Batesville, MS, Lockers Manufacturing boasts a cutting-edge facility strategically positioned for optimal accessibility. With this advantageous location, we can efficiently serve over half of the U.S. population within a mere two-day timeframe, delivering unparalleled convenience and cost savings to our valued customers.



Lockers Manufacturing remains steadfast in its commitment to excellence across key areas, including meticulous design and engineering, unparalleled manufacturing and distribution processes, operational proficiency, streamlined logistics, and value-added services.

GOING GREEN.

LOCKERS MANUFACTURING PAVING A WAY TO A GREENER FUTURE

At Lockers Manufacturing our commitment extends beyond quality products to reducing our environmental footprint from inception to disposal. We are proud recipients of UL's GREENGUARD Gold certification and SCS Indoor Advantage Gold Global Registry for our metal lockers, underscoring our dedication to sustainability and indoor air quality.



Product made with 20%-50% recycled content. **01**

02 Recycles more than 50 million pounds annually.

Our powder-coat paint is solvent-free, emitting zero Volatile Organic Compounds (VOCs) commonly found in wet paint processes. **03**

04 Powder coating operations significantly reduce waste through high efficiency application and recover methods.

Many products used in our offices, including marketing materials, are made using recycled content. **05**

06 Lockers Manufacturing partners with the Top 25 EPA certified freight carriers to ensure a green supply chain.

We recycle all used cardboard, plastic, and pre/post consumer steel material. **07**

08 We send all additional waste to a waste solutions vendor to maximize recycling efforts and increase green initiatives.

Lockers Manufacturing has a green marketing campaign, utilizing mostly digital assets. **09**



AMERICANS WITH DISABILITIES ACT.

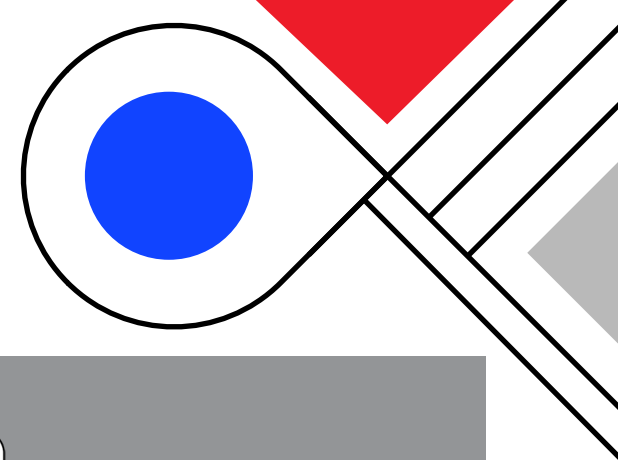

HOW LOCKERS MANUFACTURING HELPS!

Lockers Manufacturing is committed to ensuring accessibility for all individuals, including those with disabilities, in compliance with the Americans with Disabilities Act (ADA).



Our lockers are meticulously designed to meet ADA requirements, incorporating features such as appropriate height and reach for easy access, tactile signage, and accessible locking mechanisms. By prioritizing inclusivity in our designs, we empower users of all abilities to navigate and utilize our lockers with ease and confidence.

Lockers Manufacturing is dedicated to tailoring solutions to meet unique requirements. It's important to consider the clear area in front of the lockers to adhere to other related guidelines.

For further assistance, please contact a sales service representative or visit <https://www.access-board.gov/ada/> for the complete ADA Accessibility guidelines.

LOCKERS BY INDUSTRY.

WE ARE THE INDUSTRY LEADER IN PROVIDING DESIGN, MATERIALS, AND TECHNOLOGY

Thank you for exploring our catalog and considering Lockers Manufacturing as your preferred locker brand. We're eager to earn a place as an approved manufacturer in your main specification book. Our aim is to be your go-to choice, seamlessly integrating into your architectural specifications. If you're unsure where to start, we're here to assist. For any inquiries or custom locker needs not listed, please reach out to one of our dedicated sales representatives at sales@lockersmfg.com.

Athletic Facilities

- Custom Sport Lockers
- P.E. Lockers
- Custom Open Front Lockers
- Pass Through Lockers
- Football Lockers
- Baseball Lockers
- Softball Lockers
- Soccer Lockers



New Construction/ Renovation

- Specification Lockers
- Stock Lockers
- Division 10 Lockers

Fire/Rescue/Law Enforcement

- Police Lockers
- Gear Lockers
- Firefighter Lockers
- First Responder Lockers



Education Facilities

- School Lockers
- Corridor Lockers
- Classroom Lockers
- Cubbie Lockers
- Band Lockers



Healthcare Facilities

- Employee Lockers
- Anti-microbial Lockers
- Security Lockers



Manufacturing & Distribution

- Employee Lockers
- OSHA Lockers
- Office Lockers
- Wardrobe Lockers
- Laundry Lockers

Military/Government Facilities

- TA-50 Lockers
- Gun Lockers
- Military Lockers
- Postal Lockers

Smart Lockers

- Technology Lockers
- E-Commerce Lockers
- Parcel Delivering Lockers
- Asset Management lockers

Characteristics

- Heavy Duty Lockers
- Specialty Lockers
- Perforated Lockers
- Quiet Lockers
- Economy Lockers

Storage

- Cold Storage Lockers
- Bulk Storage Lockers
- Mobile Lockers
- Uniform Lockers
- Laundry Lockers

Material

- Stainless Steel Lockers
- Glass Lockers
- Angle Iron Lockers
- All-Welded Lockers
- HDPE Lockers
- Wood Lockers
- Metal Lockers



Lockes & Benches

- Built-In Key Locks
- Portable Combination
- Padlocks
- Built-In Combination Locks
- Bluetooth Locks
- Digi Locks
- Bench Tops
- Bench Pedestals



Custom

- Standard Lockers
- Hotel Lockers
- Theme Park Lockers



REQUIREMENTS & CHECKLIST.

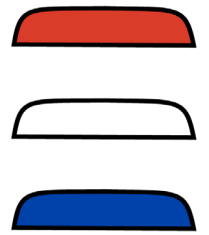

“WE ARE COMMITTED TO ETHICAL BUSINESS PRACTICES AND SOCIAL RESPONSIBILITY.”

Our locker requirements and planning checklist is here to help you consider all the important factors when selecting and installing lockers. From size and layout to various features and options, our checklist ensures you cover all the key points for a successful locker setup. Let us assist you in making informed decisions for your project.

- 1 LOCKER TYPE**
- 2 LOCKER SIZE**
(W x D x H)
- 3 CONSTRUCTION TYPE**
Welded or Knock Down
- 4 NUMBER OF OPENINGS PER FRAME**
- 5 VENTILATION TYPE**
- 6 HANDLE TYPE**
- 7 LEG/BASE TYPE**
- 8 SLOPE TOP OR FLAT TOP**
- 9 COLOR**
- 10 LOCK TYPE**

"OUR LIFETIME WARRANTY ENSURES YOUR TRUST IN EVERY LOCKER."

WARRANTY.

At Lockers Manufacturing, we proudly offer a lifetime warranty on our lockers. This warranty ensures that our products are free from defects in materials and workmanship for the entire lifetime of the locker.

Our commitment to quality and durability means you can trust that our lockers will withstand the test of time. Should any issues arise, our dedicated support team is ready to assist, ensuring your investment is protected. Experience peace of mind and unmatched reliability with Lockers Manufacturing's lifetime warranty.



*Scan me to view our
full Lifetime Warranty*



TIER OPENING & HINGES.

A TERMS TO KNOW

TIER: A “level” of a locker defined by the number of doors in a verticle row

OPENINGS: The space behind a door

FRAME: Is the unit that holds the doors

B CUSTOM DESIGNS

Lockers Manufacturing also specializes in custom design work. If your project requires a storage solution not seen throughout this catalog, please contact us.

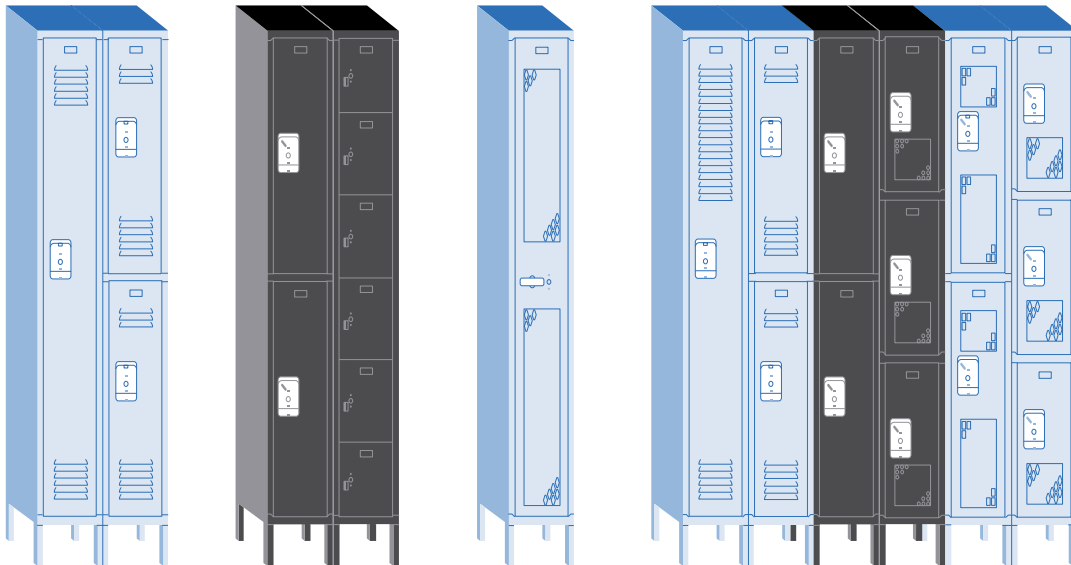

C HINGES

Standard: 16 gauge continuous piano type hinge riveted to frame and welded to door. (*shown*)

Optional: Full Loop 5 Knuckle Design Hinge

HANDLES & VENTILATION.

MULTI-POINT RECESSED HANDLE

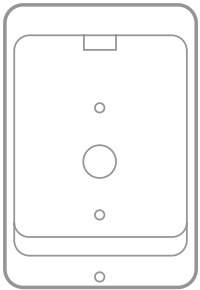

This Stainless Steel recessed cup is designed for safety, eliminating protrusion from front of locker. Can be used with built-in combination lock and portable pad locker.

SINGLE-POINT RECESSED HANDLE

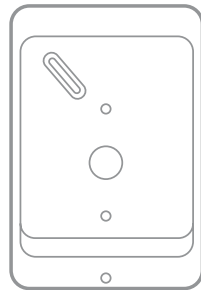

This Stainless Steel handle has no moving parts, which requires low maintenance. Equipped with Anti-Pry Latch for added security.

DOOR PULL

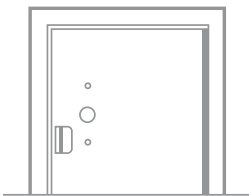

The door pull with a padlock hasp is the standard for all box lockers.

CREMONE HANDLE



An unbreakable steel handle securely bolted to a three point latching system. 3/8" latching rod engages on top and bottom of door frame. 1/8" thick center latch locks center of door to frame.

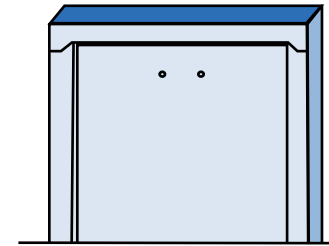

SOLID

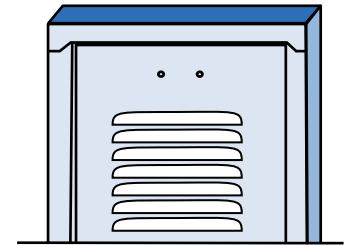

FULL LOUVERS

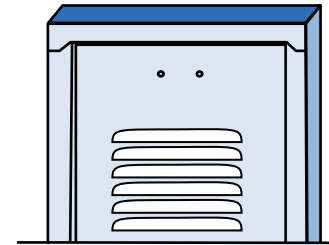

STANDARD LOUVERS

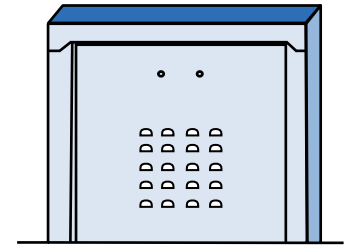

MINI LOUVERS

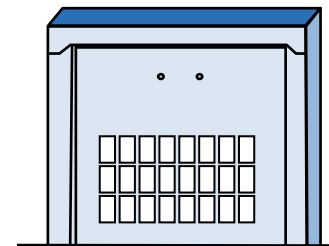

RECTANGLE PERFORATIONS

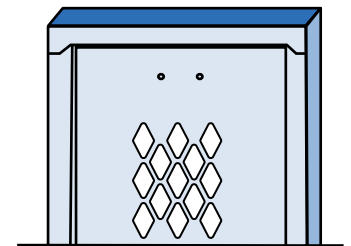

DIAMOND PERFORATIONS

LOCKERS

KNOCK DOWN.

Our Knock Down Series locker is built tough to withstand daily wear and tear, featuring a durable 2 mil thick powder coat baked enamel finish available in 20 standard colors and customizable options. Equipped with a recessed handle for enhanced safety and security, it prevents protrusions from the locker front and accommodates built-in combination locks or padlocks. Crafted from prime grade mild cold rolled sheet steel, it ensures quality and reliability, making it ideal for schools, employee lockers, and hospitals.

PRODUCT TIERS

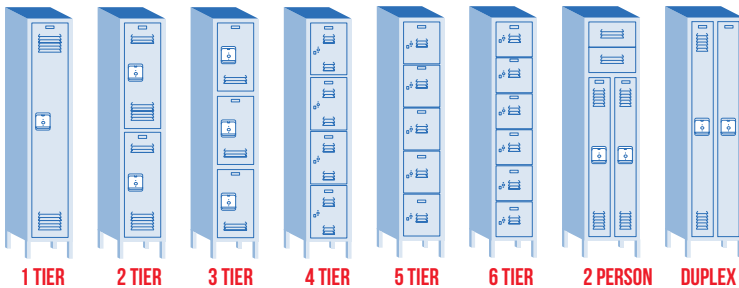

HIGH-END FEATURES

- 2 MIL thick powder coat baked to cure finish
- All doors come standard with recessed handles for added safety and security
- Standard 16 gauge continuous piano type hinges riveted to frame and welded to door
- Continuous door strike has rubber bumpers to reduce noise
- Door frame is spot welded construction
- Standard 16 gauge bottom
- Body painted to match door and frame
- Many sizes available through Fast Track Stocking Program

VENTILATION OPTIONS

- Standard louvers (standard)
- Full louvers
- Mini Louvers
- Solid
- Rectangular Perforations
- Diamond Perforations

DOOR HANDLE OPTIONS

- Recessed Handle Multi-Point Latch
- Recessed Handle Single Point Latch
- Door Pull (standard for box lockers)

GAUGE REFERENCE

Top	Back	Side	Base	Door	Door Frame	Shelf
24	24	24	16	16	16	24

KNOCK DOWN SPECIALITY.

DUAL LOCKERS



A dual locker is a single tier locker with a vertical partition separating the area beneath the shelf into two compartments. It is generally used with lockers 15" or 18" wide and 18" or 21" deep

HALF HEIGHT, 1 TIER



Available in 30-1/2", 36-1/2", and 48-1/2" heights; Available in 12", 15" and 18" depths; 12" wide. Only 48-1/2" high lockers include a shelf for storage. (books, small items, etc.)

16 PERSON LOCKER

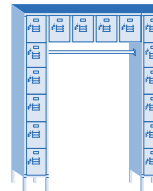

Accommodates 16 users in only 69" of floor space. Includes a 45" wide coat rod. Ideal for employee lockers. Accepts built-in locks or padlocks. 69"W x 18"D x 72"H.

WALL MOUNTED LOCKER WITH COAT ROD



A practical storage unit where space is at a premium. Four private compartments with a hanging area for approximately 16 coats. When mounted to a wall, the floor below is kept clear for easy cleaning. 45"W x 18"D x 13-5/8"H.

7 & 8 PERSON LOCKER

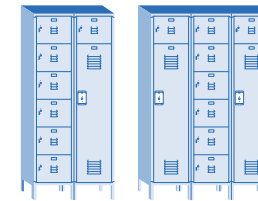

The box compartments measurement is 18"W x 12"H. The locker measurement is 18"W x 60"H.

BOX OVER LOCKER



Provides a compact independent lockable door above a 60" high standard Durable Door. If a shelf is required in the lower compartment, it must be ordered separately.

ONE HIGH BOX LOCKER



This 12" wide individual one high box locker provides storage for personal items and features standard box locker construction with door pull. Actual height is 13-5/8".

PRODUCT FABRICATION

Material: Steel parts shall be mild cold rolled commercial quality steel, capable of taking a high-grade finish. Steel mandrel rivets, zinc-plated truss, and fin head bolts with hex nuts.

Fabrication: Each locker will have an individual door, frame, top, bottom, back, and shelves, with common intermediate divisions.

Construction: Lockers shall be built with common intermediate uprights separating units. Assembly using rivets and/or nuts and bolts. Lockers shall be square, rigid, without warp, with metal faces. Doors shall be flat and distortion-free.

Door Frames: Shall be 16 gauge, channel-shaped with an additional flange for a continuous door strike. Cross-frame members shall also be 16 gauge channel-shaped and securely welded for rigidity.

Doors: Shall be 16 gauge with louvers for ventilation. Doors 12" wide and over or 20" high are 16 gauge sheet steel. Doors less than 12" wide are 18 gauge sheet steel. Doors over 15" wide by 60" or 72" high include a 3" wide 20 gauge full-height reinforcing pan welded inside.

Ventilation: Louvered doors in standard louver pattern.

Body: Hole spacing not exceeding 9". Steel specially formed for added strength and rigidity.

Box Lockers: Channel formations on lock and hinge sides, pre-punched for padlocks, latch, door pull, and built-in combination and key locks.

Hinges: Shall be 16 gauge full-length continuous piano type, riveted to the frame and welded to the door. Designed for security and resistance to abuse.

Handles: One piece 20 gauge deep-drawn stainless cup, designed to accommodate locks.

Latching: Single, double, triple, and two-person lockers have a 14 gauge steel lifting trigger with a padlock eye. Rubber silencer secured to the frame at each latch hook.

Interior Equipment: Single-tier lockers 48" or higher have a shelf. Lockers under 18" deep have 3 wall hooks and one ceiling hook. Lockers 18" deep or more have a coat rod instead of one ceiling hook. Triple-tier lockers have three or four wall hooks. Hooks are zinc-plated steel with ballpoint heads and attached with two fasteners.

Number Plates: Each locker has a polished aluminum number plate with black numerals 1/2" high.

Finish: All components have a 2mm hybrid epoxy/polyester powder, electrostatically applied and baked to cure.

Submittals: Submit under provisions of Section 01 33 00. Shop drawings to show dimensioned plans, elevations, and sections.

Accessories: Available upon request.

Locks: Available upon request.

ADA Compliance: Lockers meet ADA guidelines. They have recessed handles, are single-tier or lower opening of a double-tier locker, and have bottoms at least 15" off the floor. Single-tier lockers have a shelf 48" off the floor. Handicapped doors have an appropriate symbol.

EXECUTION

Installation: Lockers must be installed in accordance with Lockers Manufacturing's provided instructions, ensuring level, plumb, and flush surfaces with secure attachments to anchoring surfaces.

Assembly: While bolting assembly is acceptable, Lockers Manufacturing recommends riveting for a solid, permanent fastening solution, allowing for efficient removal by drilling when necessary for future locker rearrangements or part replacements.

Anchoring: Securely anchor lockers to the floor and wall to maintain stability.

Adjust and Clean: Prior to substantial completion, ensure doors and latches operate smoothly without binding. Verify satisfactory operation of built-in locks to prevent any issues, adjusting as necessary for seamless functionality.

Touch-Up: Utilize factory-supplied paint for touch-ups or replacements to address any damage before substantial completion.

Protection: Take measures to protect installed products until the project is completed to maintain their integrity.

Delivery, Storage, and Handling: Store products in their original, unopened packaging until installation to safeguard the locker finish and adjacent surfaces from potential damage.



KNOCK DOWN PLUS.

Introducing the Knock Down Plus locker, designed for above-average durability. Featuring a standard 2 mil thick powder coat baked enamel finish in 20 standard colors or custom options, it combines strength with aesthetic versatility. Equipped with sound-dampening features and a 16-gauge reinforcement spot welded hat channel/door stiffener, the Knock Down Plus door ensures durability. Its recessed handle enhances safety and security, accommodating built-in locks or padlocks. With solid 14-gauge doors, rubber bumpers on latch hooks, and a Single Point Latch design, these lockers offer quiet operation and minimal maintenance. Ideal for schools, employee lockers, and hospitals, the Knock Down Plus series delivers reliability and efficiency.

PRODUCT TIERS

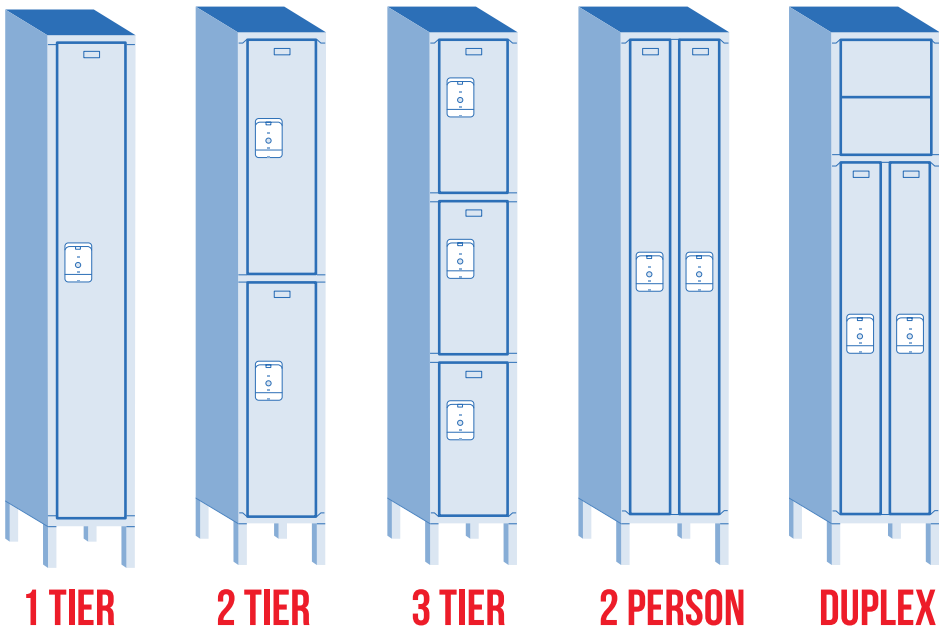

HIGH-END FEATURES

- 2 MIL thick powder coat baked to cure finish
- All doors come standard with recessed handles for added safety and security
- Standard 16 gauge continuous piano type hinges riveted to frame and welded to door
- Continuous door strike has rubber bumpers to reduce noise
- Door frame is spot welded construction
- Standard 14 gauge door with reinforcement hat channel/door stiffener
- Standard 16 gauge bottom
- Body painted to match door and frame

VENTILATION OPTIONS

- Solid (standard)
- Mini Louvers
- Standard
- Rectanular Perforations
- Diamond Perforations

DOOR HANDLE OPTIONS

- Recessed Handle Multi-Point Latch
- Recessed Handle Single Point Latch
- Door Pull (standard for box lockers)

GAUGE REFERENCE

Top	Back	Side	Base	Door	Door Frame	Shelf
24	24	24	16	14	16	24

PRODUCT FABRICATION

Material: Steel parts shall be mild cold rolled commercial quality steel, capable of taking a high-grade finish. Steel mandrel rivets, zinc-plated truss, and fin head bolts with hex nuts.

Fabrication: Each locker will have an individual door, frame, top, bottom, back, and shelves, with common intermediate divisions.

Construction: Lockers shall be built with common intermediate uprights separating units. Assembly using rivets and/or nuts and bolts. Lockers shall be square, rigid, without warp, with metal faces. Doors shall be flat and distortion-free.

Door Frames: Shall be 16 gauge, channel-shaped with an additional flange for a continuous door strike. Cross-frame members shall also be 16 gauge channel-shaped and securely welded for rigidity.

Doors: Shall be 14 gauge with louvers for ventilation. Doors 12" wide and over or 20" high are 16 gauge sheet steel. Doors less than 12" wide are 18 gauge sheet steel. Doors over 15" wide by 60" or 72" high include a 3" wide 20 gauge full-height reinforcing pan welded inside.

Ventilation: Flush door wfront with no exposed louvers and air flow slots located in top/bottom flanges of door.

Body: Hole spacing not exceeding 9". Steel specially formed for added strength and rigidity.

Box Lockers: Channel formations on lock and hinge sides, pre-punched for padlocks, latch, door pull, and built-in combination and key locks.

Hinges: Shall be 16 gauge full-length continuous piano type, riveted to the frame and welded to the door. Designed for security and resistance to abuse.

Handles: One piece 20 gauge deep-drawn stainless cup, designed to accommodate locks.

Latching: Single, double, triple, and two-person lockers have a 14 gauge steel lifting trigger with a padlock eye. Rubber silencer secured to the frame at each latch hook.

Interior Equipment: Single-tier lockers 48" or higher have a shelf. Lockers under 18" deep have 3 wall hooks and one ceiling hook. Lockers 18" deep or more have a coat rod instead of one ceiling hook. Triple-tier lockers have three or four wall hooks. Hooks are zinc-plated steel with ballpoint heads and attached with two fasteners.

Number Plates: Each locker has a polished aluminum number plate with black numerals 1/2" high.

Finish: All components have a 2mm hybrid epoxy/polyester powder, electrostatically applied and baked to cure.

Submittals: Submit under provisions of Section 01 33 00. Shop drawings to show dimensioned plans, elevations, and sections.

Accessories: Available upon request.

Locks: Available upon request.

ADA Compliance: Lockers meet ADA guidelines. They have recessed handles, are single-tier or lower opening of a double-tier locker, and have bottoms at least 15" off the floor. Single-tier lockers have a shelf 48" off the floor. Handicapped doors have an appropriate symbol.

EXECUTION

Installation: Lockers must be installed in accordance with Lockers Manufacturing's provided instructions, ensuring level, plumb, and flush surfaces with secure attachments to anchoring surfaces.

Assembly: While bolting assembly is acceptable, Lockers Manufacturing recommends riveting for a solid, permanent fastening solution, allowing for efficient removal by drilling when necessary for future locker rearrangements or part replacements.

Anchoring: Securely anchor lockers to the floor and wall to maintain stability.

Adjust and Clean: Prior to substantial completion, ensure doors and latches operate smoothly without binding. Verify satisfactory operation of built-in locks to prevent any issues, adjusting as necessary for seamless functionality.

Touch-Up: Utilize factory-supplied paint for touch-ups or replacements to address any damage before substantial completion.

Protection: Take measures to protect installed products until the project is completed to maintain their integrity.

Delivery, Storage, and Handling: Store products in their original, unopened packaging until installation to safeguard the locker finish and adjacent surfaces from potential damage.



KNOCK DOWN HEAVY DUTY.

Our Knock Down Heavy Duty lockers are designed for maximum ventilation and strength, perfect for applications requiring visual inspection of contents. They offer durability and aesthetic versatility, featuring a standard 2 mil thick powder coat baked enamel finish in 20 standard colors or custom options. With diamond perforations on doors and sides for optimal airflow and security, these lockers provide customizable options including solid doors. Equipped with a recessed handle and single-point latch (with optional multipoint latch), they ensure secure storage. Ideal for schools, gyms, recreation centers, and various other applications, our Heavy Duty lockers offer reliable storage solutions for diverse needs.

PRODUCT TIERS



1 TIER **2 TIER** **3 TIER** **4 TIER** **5 TIER** **6 TIER** **8 TIER** **9 TIER**

HIGH-END FEATURES

- 2 mil thick powder coat baked to cure finish
- Standard recessed handle on 1, 2 and 3 tier and half height locker for added safety and security
- Standard 16 gauge continuous piano type hinges riveted to frame and welded to door
- Continuous door strike has rubber bumpers to reduce noise
- Door frame is spot welded construction
- Standard 14 gauge door with reinforcement hat channel/door stiffener
- Standard 16 gauge bottom
- Single Point Latch with no moving parts, low maintenance, tamper resistant

VENTILATION OPTIONS

- Diamond Perforations (standard)
- Standard Louvers
- Mini Louvers
- Solid

DOOR HANDLE OPTIONS

- Recessed Handle Multi-Point Latch
- Recessed Handle Single Point Latch
- Door Pull (standard for box lockers)

GAUGE REFERENCE

Top	Back	Side	Base	Door	Door Frame	Shelf
16	18	16	16	14	16	16

PRODUCT FABRICATION

Material: Steel parts shall be mild cold rolled commercial quality steel, capable of taking a high-grade finish. Steel mandrel rivets, zinc-plated truss, and fin head bolts with hex nuts.

Fabrication: Each locker will have an individual door, frame, top, bottom, back, and shelves, with common intermediate divisions.

Construction: Lockers shall be built with common intermediate uprights separating units. Assembly using rivets and/or nuts and bolts. Lockers shall be square, rigid, without warp, with metal faces. Doors shall be flat and distortion-free.

Door Frames: Shall be 16 gauge, channel-shaped with an additional flange for a continuous door strike. Cross-frame members shall also be 16 gauge channel-shaped and securely welded for rigidity.

Doors: Shall be 14 gauge, channel-shaped on lock and hinge sides, with angle formations across top and bottom. One, two, and three-tier locker doors shall have 16 gauge full-height reinforcement channel. Doors over 15" wide and 30" high include a 3" wide 20 gauge full-height reinforcing pan welded inside at 6" centers. Standard with 6" legs; no legs optional.

Ventilation: All lockers sides and doors 20" or higher shall be diamond-shape perforations. Optional ventilation patterns available upon request.

Body: Hole spacing not exceeding 9". Steel specially formed for added strength and rigidity.

Box Lockers: Channel formations on lock and hinge sides, pre-punched for padlocks, latch, door pull, and built-in combination and key locks.

Hinges: Shall be 16 gauge full-length continuous piano type, riveted to the frame and welded to the door. Designed for security and resistance to abuse.

Handles: One piece 20 gauge deep-drawn stainless cup, designed to accommodate locks.

Latching: Multi-point latch with full channel formation to conceal lock bar, channel on hinge side, right-angle formations on top and bottom, and holes for number plates.

Interior Equipment: Single-tier lockers 48" or higher have a shelf. Lockers under 18" deep have 3 wall hooks and one ceiling hook. Lockers 18" deep or more have a coat rod instead of one ceiling hook. Triple-tier lockers have three or four wall hooks. Hooks are zinc-plated steel with ballpoint heads, attached with two fasteners.

Number Plates: Each locker has a polished aluminum number plate with black numerals 1/2" high.

Finish: All components have a 2mm hybrid epoxy/polyester powder, electrostatically applied and baked to cure.

Submittals: Submit under provisions of Section 01 33 00. Shop drawings to show dimensioned plans, elevations, and sections.

Accessories: Available upon request.

Locks: Available upon request.

ADA Compliance: Lockers meet ADA guidelines with recessed handles, single-tier or lower double-tier openings, and bottoms at least 15" off the floor. Single-tier lockers have a shelf 48" off the floor. Handicapped doors display an appropriate symbol.

EXECUTION

Installation: Lockers must be installed in accordance with Lockers Manufacturing's provided instructions, ensuring level, plumb, and flush surfaces with secure attachments to anchoring surfaces.

Assembly: While bolting assembly is acceptable, Lockers Manufacturing recommends riveting for a solid, permanent fastening solution, allowing for efficient removal by drilling when necessary for future locker rearrangements or part replacements.

Anchoring: Securely anchor lockers to the floor and wall to maintain stability.

Adjust and Clean: Prior to substantial completion, ensure doors and latches operate smoothly without binding. Verify satisfactory operation of built-in locks to prevent any issues, adjusting as necessary for seamless functionality.

Touch-Up: Utilize factory-supplied paint for touch-ups or replacements to address any damage before substantial completion.

Protection: Take measures to protect installed products until the project is completed to maintain their integrity.

Delivery, Storage, and Handling: Store products in their original, unopened packaging until installation to safeguard the locker finish and adjacent surfaces from potential damage.



OPEN FRONT.

The Open Front Knock Down locker is ideal for athletic team rooms, police, firefighters, first responders, and any setting requiring easy access to uniforms and gear. With customizable configurations and available in 20 standard colors or custom options, these lockers cater to specific needs. Constructed with a 16-gauge steel door frame and diamond-perforated sides for ventilation and personal space, they offer durability and comfort. Equipped with an Open Front design featuring a security box and lockable footlocker with a hinged seat, they provide secure storage while optimizing space and convenience.

PRODUCT TIERS

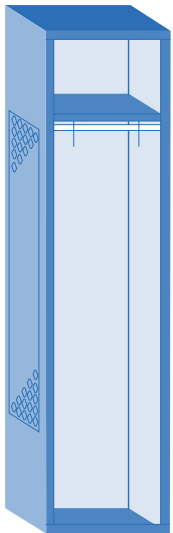

KD W/ SHELF

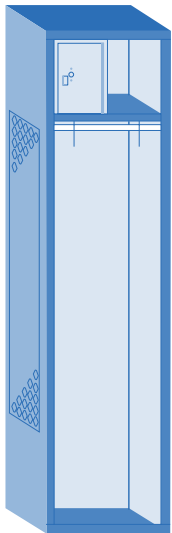

KD W/ SHELF & SECURITY BOX

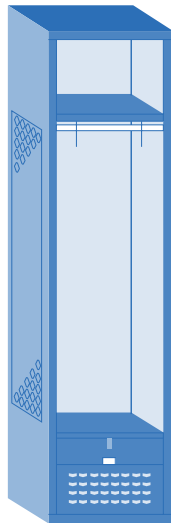

KD W/ SHELF & FOOT LOCKER

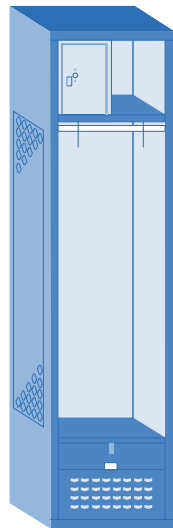

KD W/ SECURITY BOX & FOOT LOCKER

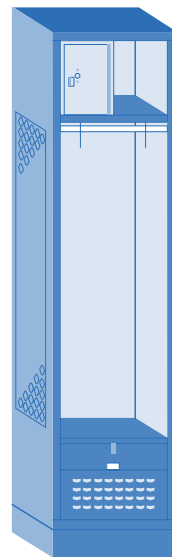

ALL WELDED W/ BASE

HIGH-END FEATURES

- 2 mil thick powder coat baked to cure finish
- Rubber bumpers mounted to contact points for quieter operation
- Door frame is spot welded construction
- Knocked Down or All Welded construction
- Open front style
- Standard option has full width shelf, 2 coat hooks and a coat rod
- 16", 24" and 33" wide models

VENTILATION OPTIONS

- Sides - Diamond Perforation (standard) ; Solid (optional)
- Foot Locker - Mini Louvers (standard) ; Solid (optional)
- Security Box - Solid (standard) ; Standard Louvers (optional)

DOOR HANDLE OPTIONS

- Security Box - Door Pull
- Foot locker - Pad Lock Hasp

GAUGE REFERENCE

Top	Back	Side	Base	Door	Door Frame	Shelf
16	18	16	16	14	16	16

PRODUCT FABRICATION

Material: Steel parts shall be mild cold rolled commercial quality steel, capable of taking a high-grade finish. Steel mandrel rivets, zinc-plated truss, and fin head bolts with hex nuts.

All-Welded

Construction: Pre-assemble lockers by welding into one piece structures in groupings most practical for job requirements, welds free of burrs; max width of groups to be 54"; no bolts, nuts or rivets allowed in assembly of main locker groups.

Body: Steel specially formed for added strength and rigidity and to ensure tight joints at fastening points.

Available only in all-welded: option of 45° angled sides

Knock Down:

Construction: Lockers shall be built on a unit principal with common intermediate uprights separating units.

Locker body assembly using rivets and/or nuts and bolts.

Body: Hole spacing in locker body construction: not exceeding 9". Steel specially formed for added strength and rigidity and to ensure tight joint at fastening points.

All-Welded and Knock Down:

Door Frames: Shall be 16 gauge, channel-shaped with an additional flange for a continuous door strike.

Cross-frame members shall also be 16 gauge channel-shaped and securely welded for rigidity.

Ventilation: All lockers sides and doors 20" or higher shall be diamond-shape perforations. Optional ventilation patterns available upon request.

Box Lockers Security Box: Channel formations on lock and hinge sides, pre-punched for padlocks, latch, door pull, and built-in combination and key locks.

Foot Locker: With hinged bench seat, padlock hasp and stainless steel strike. Hinge is 16 gauge continuous and riveted to horizontal panel.

Interior Equipment: Full width shelf, coat rod and two single prong hooks.

Number Plates: Each locker has a polished aluminum number plate with black numerals 1/2" high.

Finish: All components have a 2mm hybrid epoxy/polyester powder, electrostatically applied and baked to cure.

Submittals: Submit under provisions of Section 01 33 00. Shop drawings to show dimensioned plans, elevations, and sections.

Accessories: Available upon request.

Locks: Available upon request.

ADA Compliance: Lockers meet ADA guidelines with recessed handles, single-tier or lower double-tier openings, and bottoms at least 15" off the floor. Single-tier lockers have a shelf 48" off the floor. Handicapped doors display an appropriate symbol.

EXECUTION

Installation: Lockers must be installed in accordance with Lockers Manufacturing's provided instructions, ensuring level, plumb, and flush surfaces with secure attachments to anchoring surfaces.

Assembly: While bolting assembly is acceptable, Lockers Manufacturing recommends riveting for a solid, permanent fastening solution, allowing for efficient removal by drilling when necessary for future locker rearrangements or part replacements.

Anchoring: Securely anchor lockers to the floor and wall to maintain stability.

Adjust and Clean: Prior to substantial completion, ensure doors and latches operate smoothly without binding. Verify satisfactory operation of built-in locks to prevent any issues, adjusting as necessary for seamless functionality.

Touch-Up: Utilize factory-supplied paint for touch-ups or replacements to address any damage before substantial completion.

Protection: Take measures to protect installed products until the project is completed to maintain their integrity.

Delivery, Storage, and Handling: Store products in their original, unopened packaging until installation to safeguard the locker finish and adjacent surfaces from potential damage.

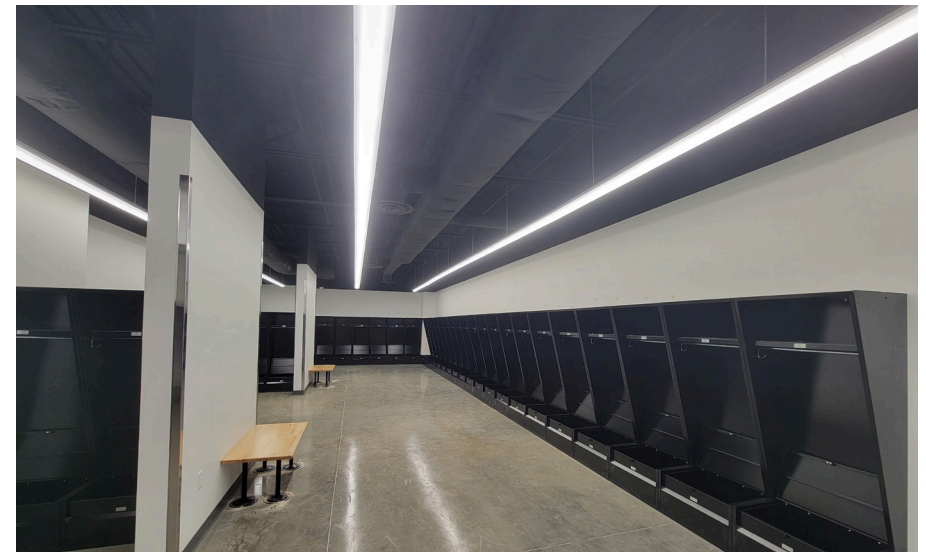

ALL WELDED.

The All Welded locker offers superior durability against hard use and abuse, with all components welded into a single rigid unit for lifelong resilience. Featuring a standard 2 mil thick powder coat in 20 standard colors or custom options, they ensure both strength and aesthetic appeal. Constructed with 16-gauge door frames and sides, as well as 14-gauge steel doors with continuous piano hinges, these lockers are built to last. Available in various ventilation options, including diamond-perforated doors for optimal airflow, they cater to diverse needs. Compatible with built-in locks and padlocks, they also feature rubber bumpers on latch hooks to minimize noise.

PRODUCT TIERS

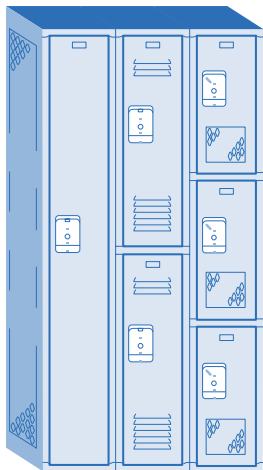

1, 2 & 3 TIER

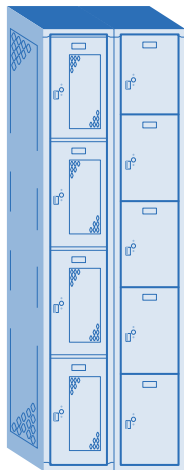

4 & 5 TIER

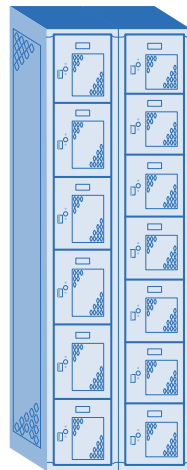

6 & 8 TIER



9 TIER

HIGH-END FEATURES

- 2 mil thick powder coat baked to cure finish
- All doors come standard with recessed handles for added safety and security
- Standard 16 gauge continuous piano type hinges riveted to frame and welded to door
- Continuous door strike has rubber bumpers to reduce noise
- Standard 14 gauge door with reinforcement hat channel/door stiffener
- Standard 16 gauge bottom
- Heavy duty gauges
- Ships Fully Assembled

VENTILATION OPTIONS

- Diamond Perforations (standard)
- Solid
- Standard Louvers
- Mini Louvers
- Rectangular Perforations

DOOR HANDLE OPTIONS

- Recessed Handle Multi Point Latch
- Recessed Handle Single Point Latch
- Door Pull (standard for box lockers)

GAUGE REFERENCE

Top	Back	Side	Base	Door	Door Frame	Shelf
16	18	16	16	14	16	16

PRODUCT FABRICATION

Material: Steel parts shall be mild cold rolled commercial quality steel, capable of taking a high-grade finish. Steel mandrel rivets, zinc-plated truss, and fin head bolts with hex nuts.

Fabrication: Shall be on the unit principal, each locker with individual door and frame, individual top, bottom, back, and shelves, with common intermediate divisions separating compartments.

Construction: Pre-assemble lockers by welding into one piece structures in groupings most practical for job requirements, welds free of burrs; max width of groups to be 54".

Door Frames: Shall be 16 gauge formed in a channel shape with continuous vertical door strike.

Doors: 14 gauge steel formations are full channel shape on the lock side adequate depth to fully conceal the lock bar, channel formation on the hinge side, and right angle formations across the top and bottom. the lock bar, channel formation on the hinge side, and right angle formations across the top and bottom.

Ventilation: All lockers sides and doors 20" or higher shall be diamond-shape perforations. Optional solid doors and sides.

Body: Steel specially formed for added strength and rigidity and to ensure tight joints at fastening points.

Box Lockers: Door shall be 14 gauge steel, punched for built in lock or pad lock. Equip doors for use with padlocks with an 18 gauge combination door pull, staple, and lock hole cover plate with integral friction.

Hinges: Shall be 16 gauge full length continuous piano type riveted to both door and frame. Hinge shall maximize security and enhance resistance to abuse and vandalism.

Handle & Latching: Handles shall be recessed in the door and be finger lift control. Drawn pocket shall be 20 gauge brushed stainless steel securely fastened to the door with two tabs plus a positive tamper resistant decorative fastener. The pocket shall be of sufficient depth to prevent a combination padlock, built in combination lock or key lock from protruding beyond the face of the door.

Interior Equipment: Full width shelf, coat rod, and two single prong hooks.

Number Plates: Provide holes for attaching number plates. Each locker shall have a polished aluminum number plate riveted to door face with black numerals 1/2" high.

Finish: All components shall have a 2mm hybrid epoxy/polyester powder, electrostatically applied to ensure a uniform finished and baked to cure.

Submittals: Submit under provisions of Section 01 33 00. Shop drawing shall show dimensioned plans, elevation, and sections.

Accessories: Available upon request.

Locks: Available upon request.

ADA Compliance: Lockers meet ADA guidelines with recessed handles, single-tier or lower double-tier openings, and bottoms at least 15" off the floor. Single-tier lockers have a shelf 48" off the floor. Handicapped doors display an appropriate symbol.

Options: Customizable metal base.

EXECUTION

Installation: Lockers must be installed in accordance with Lockers Manufacturing's provided instructions, ensuring level, plumb, and flush surfaces with secure attachments to anchoring surfaces.

Anchoring: Securely anchor lockers to the floor and wall to maintain stability.

Adjust and Clean: Prior to substantial completion, ensure doors and latches operate smoothly without binding. Verify satisfactory operation of built-in locks to prevent any issues, adjusting as necessary for seamless functionality.

Touch-Up: Utilize factory-supplied paint for touch-ups or replacements to address any damage before substantial completion.

Protection: Take measures to protect installed products until the project is completed to maintain their integrity.

Delivery, Storage, and Handling: Store products in their original, unopened packaging until installation to safeguard the locker finish and adjacent surfaces from potential damage.

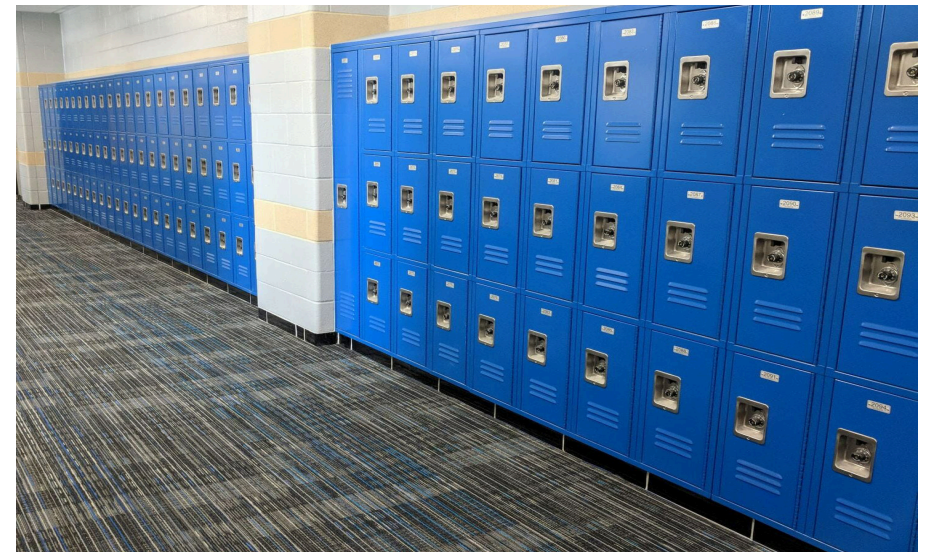

ANGLE IRON.

Angle Iron lockers feature a sturdy 1" x 1" x 1/8" angle iron frame, providing robust edges and a solid structure. With diamond perforated doors and sides, they ensure ample airflow. Available in 20 standard colors or custom options, these lockers boast a durable 2 mil thick powder coat finish. Built with 16-gauge top and bottom panels and 18-gauge backs spanning multiple units, they minimize seams for enhanced strength. The common intermediate vertical door frame channels streamline construction, while riveted hinges offer maintenance flexibility. Ideal for gyms, field houses, military, police, and firefighters, Angle Iron lockers offer durability and functionality.

PRODUCT TIERS

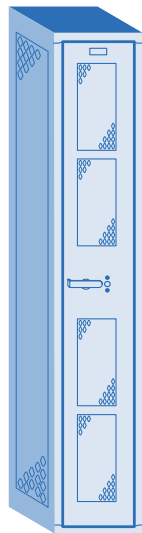

1 TIER

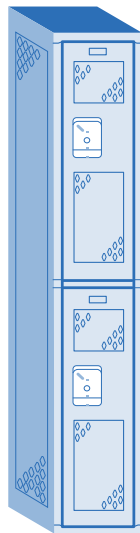

2 TIER

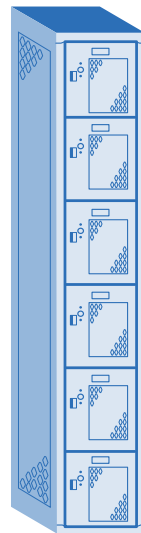

6 TIER

HIGH-END FEATURES

- 2 mil thick powder coat baked to cure finish
- Standard Single Point Latch
- Standard 16 gauge continuous piano type hinges riveted to frame and welded to door
- Continuous door strike has rubber bumpers to reduce noise
- Fully welded angle frame construction
- Standard 13 gauge door with reinforced hat channel/door stiffener
- Standard 16 gauge bottom
- Available in 1, 2 and 6 tier

VENTILATION OPTIONS

- Diamond Perforations (standard)
- Standard Louvers
- Solid

DOOR HANDLE OPTIONS

- Recessed Handle Single point Latch
- Recessed Handle Multi Point Latch
- Door Pull

GAUGE REFERENCE

Top	Back	Side	Base	Door	Door Frame	Shelf
16	18	14	16	14	1/8"	16

PRODUCT FABRICATION

Material: Steel parts shall be mild cold rolled commercial quality steel, capable of taking a high-grade finish. Steel mandrel rivets, zinc-plated truss, and fin head bolts with hex nuts.

Fabrication: Shall be on the unit principal, each locker with individual door and frame, individual top, bottom, back, and shelves, with common intermediate divisions separating compartments.

Construction: Pre assemble lockers by welding into one piece structures in groupings most practical for job requirements, welds free of burrs; max width of groups to be 54" ; no bolts, nuts, or rivets allowed in assembly of main locker groups.

Door Frames: Shall be continuous 1"x1"x1/8" pretreated angle iron steel.

Doors: 14 gauge steel with double bends on vertical sides and a single bend on horizontal sides.

Ventilation: All lockers sides and doors 20" or higher shall be diamond-shape perforations. Optional solid doors and sides.

Body: Steel specially formed for added strength and rigidity and to ensure tight joints at fastening points.

Box Lockers: Door shall be 14 gauge steel, punched for built in lock or pad lock. Equip doors for use with padlocks with an 18 gauge combination door pull, staple, and lock hole cover plate with integral friction.

Hinges: Shall be 16 gauge full length continuous piano type riveted to both door and frame. Hinge shall maximize security and enhance resistance to abuse and vandalism.

Handle: Single point latching with recessed 20 gauge brushed stainless steel handle, securely fastened with tamper-resistant fasteners. Pocket depth prevents locks from protruding. Includes padlock staple, lock hole cover plate, and 11 gauge steel hasp with anti-pry features. Rubber silencers are firmly secured to the locker frame.

Latching: 3-point Cremona Multipoint Latch with unbreakable steel handle welded to a 3-point mechanism. 3/8" diameter latching rods engage top and bottom edges; 1/8" center latch engages the jamb, securing the door on three sides. Compatible with padlocks and built-in deadbolt locks. Interior Equipment: Full width shelf, coat rod, and two single prong hooks.

Number Plates: Provide holes for attaching number plates. Each locker shall have a polished aluminum number plate riveted to door face with black numerals 1/2" high.

Finish: All components shall have a 2mm hybrid epoxy/polyester powder, electrostatically applied to ensure a uniform finished and baked to cure.

Submittals: Submit under provisions of Section 01 33 00. Shop drawing shall show dimensioned plans, elevation, and sections.

Accessories: Available upon request.

Locks: Available upon request.

ADA Compliance: Lockers meet ADA guidelines with recessed handles, single-tier or lower double-tier openings, and bottoms at least 15" off the floor. Single-tier lockers have a shelf 48" off the floor. Handicapped doors display an appropriate symbol.

Integral Metal Base: 4" or 6" high, 16 gauge steel channel, welded to the locker bottom.

EXECUTION

Installation: Lockers must be installed in accordance with Lockers Manufacturing's provided instructions, ensuring level, plumb, and flush surfaces with secure attachments to anchoring surfaces.

Anchoring: Securely anchor lockers to the floor and wall to maintain stability.

Adjust and Clean: Prior to substantial completion, ensure doors and latches operate smoothly without binding. Verify satisfactory operation of built-in locks to prevent any issues, adjusting as necessary for seamless functionality.

Touch-Up: Utilize factory-supplied paint for touch-ups or replacements to address any damage before substantial completion.

Protection: Take measures to protect installed products until the project is completed to maintain their integrity.

Delivery, Storage, and Handling: Store products in their original, unopened packaging until installation to safeguard the locker finish and adjacent surfaces from potential damage.

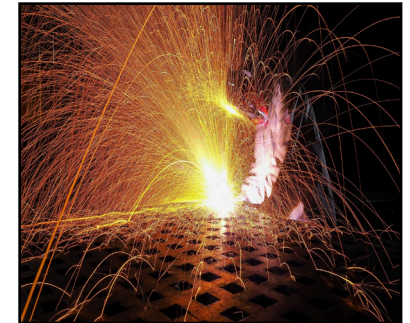

“PRECISION WITH EVERY STEP!”



STEEL COLOR CHART.



Colors shown are an approximate printed representation of the actual colors and may vary. Actual color samples are available upon request.

Lockers Manufacturing retains the right of reasonable color variation from samples presented.

Two-Tone: Two tone finish is available upon request with an additional fee.

Standard Finish: Provides a durable, uniform finish, offering excellent resistance to corrosion, chemicals, and abrasion. Industry leading 2-3 mils standard. Available for all color options

Custom Colors: Custom colors empower a customer to find the exact color that fits their projects needs. This is ideal for matching new lockers to existing lockers, or finding the perfect color to bring a space together.

Hammertone Finish: A textured finish that offers a unique look while adding enhanced durability. Industry leading 2-3 mils standard. Hammertone color chart available upon request.

Antimicrobial Finish: Our antimicrobial powder coating inhibits the growth of bacteria, mold, and other microbes. Industry leading 2-3 mils standard. Available for all color options.

Anti-Graffiti Finish: Provides a protective layer that allows for easy removal of graffiti and stains, preserving the finish of the product. Industry leading 2-3 mils standard. Available for all color options.

LOCKER ACCESSORIES LOCKER ACCES
SSORIES LOCKER ACCESSORIES LOCK
LOCKER ACCESSORIES LOCKER ACCES
SSORIES LOCKER ACCESSORIES LOCK
LOCKER ACCI LOCKER ACCES
SSORIES LOCKER ACCESSORIES LOCK
LOCKER/ ACCESSORIES LOCKER ACCES
SSORIES LOCKER ACCESSORIES LOCK
LOCKER ACCESSORIES LOCKER ACCES
SSORIES LOCKER ACCESSORIES LOCK
LOCKER ACCESSORIES LOCKER ACCES

LOCKER ACCESSORIES

SLOPE TOPS.

Slope tops are often favored over flat tops as they prevent the accumulation of dust and debris, discouraging the use of locker tops for storage. We offer three slope construction variations: Unit slope tops, Slope hoods, and Slope top kits (Stock converter for Standard Knock Down Series), providing versatile options for your needs.

UNIT SLOPE TOPS

Unit Slope Tops cover the width of one locker frame only. Lockers with Unit Slope Tops have sides with mitered top ends with a rise equal to 1/3 of the locker depth, plus longer backs that meet the rear edge of the slope top, Unit Slope Tops are used in place of the standard flat tops. (Not for use on Heavy Duty Series, Open Front Series or All Welded Series.)

Unit Slope Tops are available in the following width and depth:

9x12, 9x15, 9x18, 12x12, 12x15, 12x18, 12x21, 15x12, 15x15, 15x18, 15x21, 18x18, 18x21, 18x24, 24x18, 24x21 and 24x24.

Slope Top Kits are available in the following width, depth and height:

12x12x4, 12x15x4, 12x18x6, 15x15x5, 15x18x6 and 18x18x6.

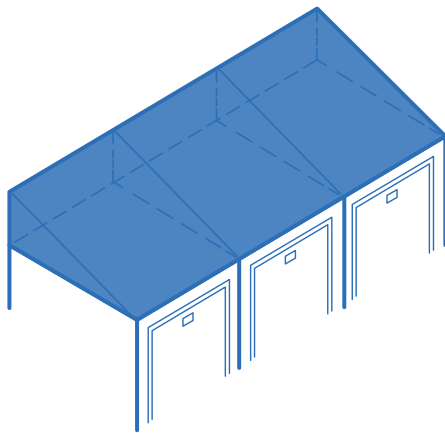

CONTINUOUS SLOPE HOODS

Continuous Slope Hoods fit on top of flat top lockers. They can be used on new lockers, or on a retrofit basis. All hoods are furnished in 72" lengths and must be cut to length during installation. Intermediate splices, ends and rear supports (2 per hood) complete the installation, and must be ordered separately.

Slope Hoods are available in the following width, depths and heights: 72x12x5, 72x15x6, 72x18x7, 72x21x8, and 72x24x9.

Slope Ends and Hood Splice available in the following depths and heights: 12x5, 15x6, 18x7, 21x8 and 24x9.

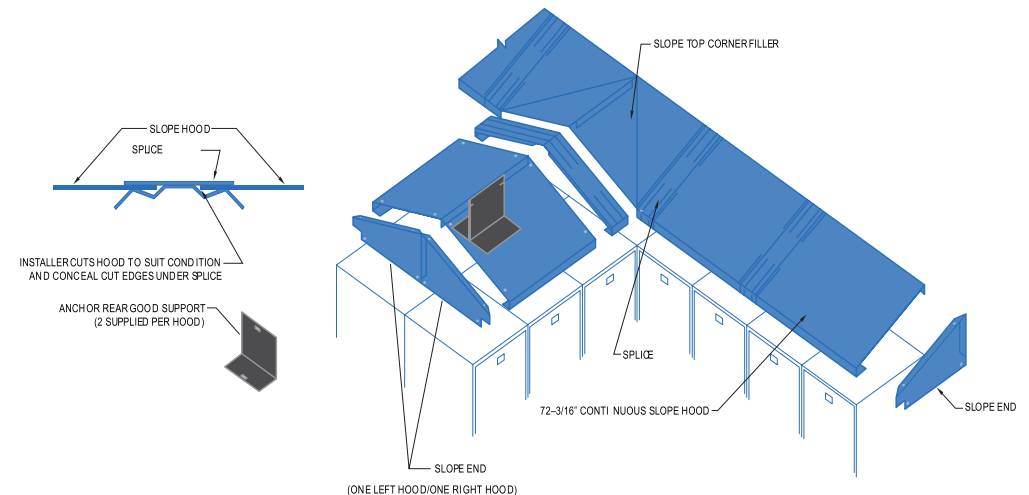

RECESS TRIM.

Recess Trim is 3" wide and bridges the gap between lockers and the wall and/or soffits when the lockers are recessed into a wall. Lockers must be anchored to base (base and wood to be completed by a general contractor.)

SIDE VIEW OF BASE & ANCHORS

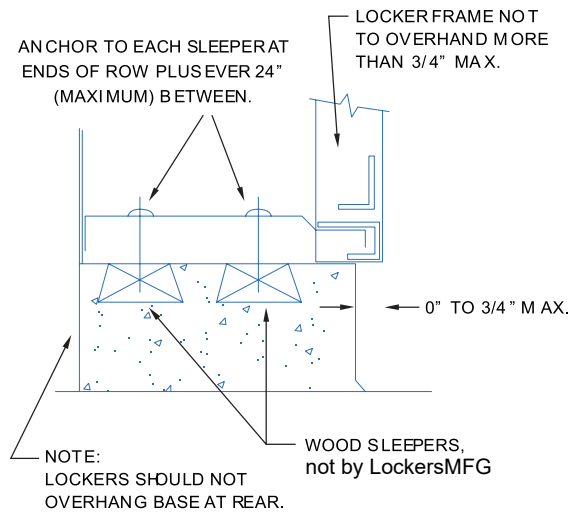

SIDE VIEW OF TOP RECESSED TRIM

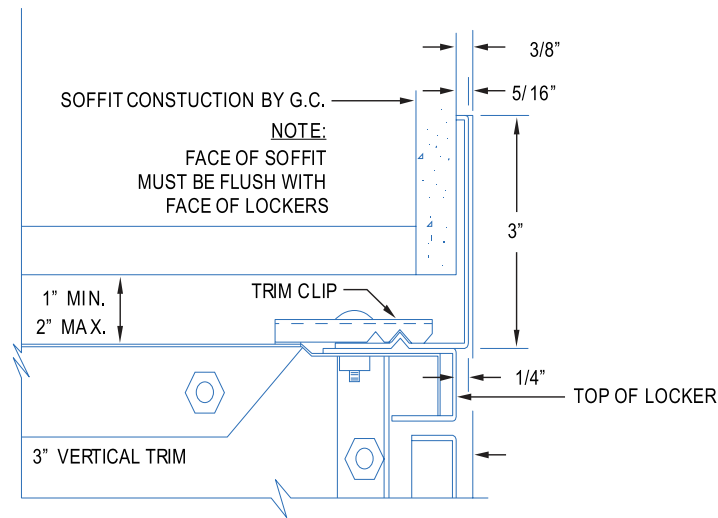

FRONT VIEW OF LOCKER WITH RECESSED TRIM

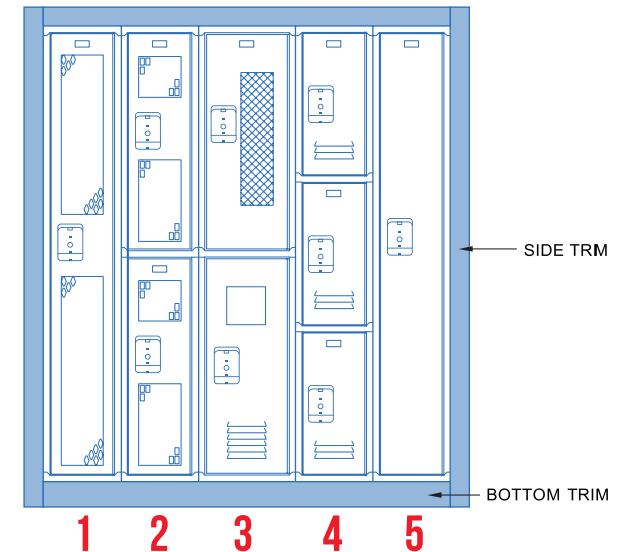

TOP VIEW OF A RECESSED LOCKER GROUPING

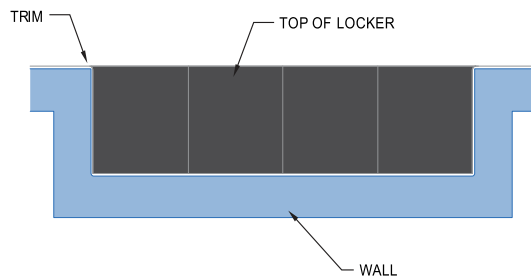

TOP VIEW OF 3" VERTICAL TRIM R.H.

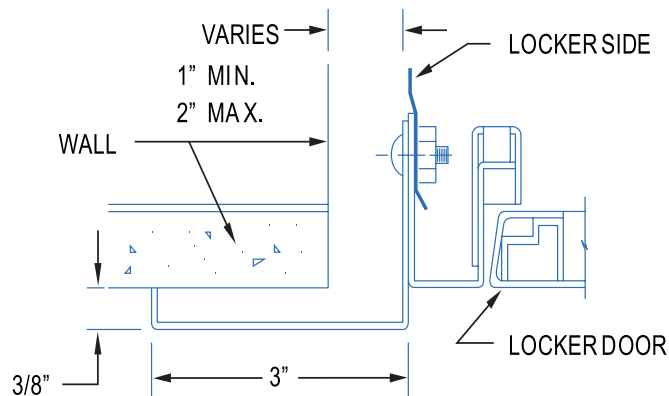

1. Competitive 1 - Tier with Diamond Perforations
2. Durable 2 - Tier with Visual Perforations
3. Fire Extinguisher / Waste Bin
4. Durable 3 - Tier with Louvers
5. Durable Plus 1 - Tier with Solid Doors

BASES.

Introducing our locker bases, available in two versatile options: individual closed bases and zee bases. Our individual closed bases offer sturdy support for each locker unit, ensuring stability and durability. Alternatively, our zee bases provide a sleek and modern aesthetic while maximizing airflow and ease of cleaning. Whether you prefer individual closed bases for a traditional look or zee bases for contemporary appeal, our bases are designed to complement any locker setup.

INDIVIDUAL CLOSED BASES

Front and End bases are designed to fit between standard Lockers Manufacturing 6" legs. They present a clean flush appearance and prevent the accumulation of dust and dirt under the lockers. (Not for use on All Welded lockers). Front base snaps in. End base slips over legs during locker assembly.

Closed bases are available in the following widths and heights:

9x6, 12x6, 15x6, 18x6 and 24x6

End bases single row are available in the following depths and heights: 12x6, 15x6, 18x6, 21x6 and 24x6

End bases double row are available in the following depths and heights: 24x6, 30x6 and 36x6

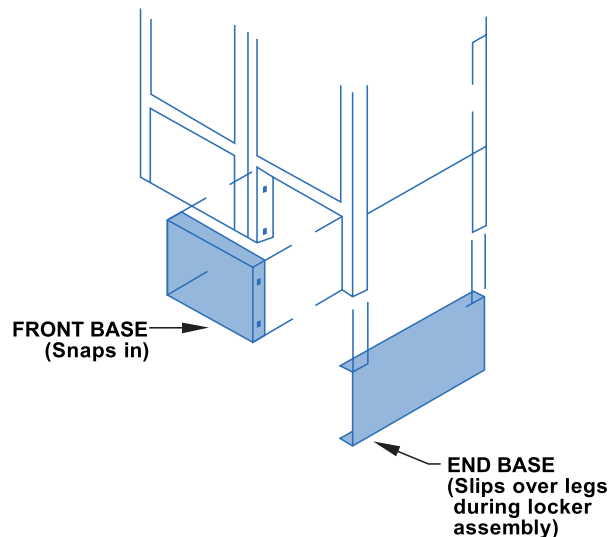

ZEE BASES

Zee bases raise lockers without 4" legs off the floor when there is no concrete or wood base. They provide a toe space in the front and a concealed flange for floor anchoring at the rear. A special 4" high rear leg can be ordered to simplify installation. Also available for 6" high zee bases.

Zee bases are available only in 72" lengths, and may need to be cut to fit at the time of installation. Splices/End Bases are used at end of rows, and where the front sections join. (Not for use on All Welded lockers).

Front zee base is available in 72 x 4.

Splice/End Base Single Row is available in the following depths and heights: 2x4, 25x4, 18x4, 21x4 and 24x4

Splice/End Base Double Row is available in the following depths and heights: 30x4, 24x4 and 36x4

Zee Base Filler is available in a 4" height.

Rear leg for Zee Base is available in a 4" height.

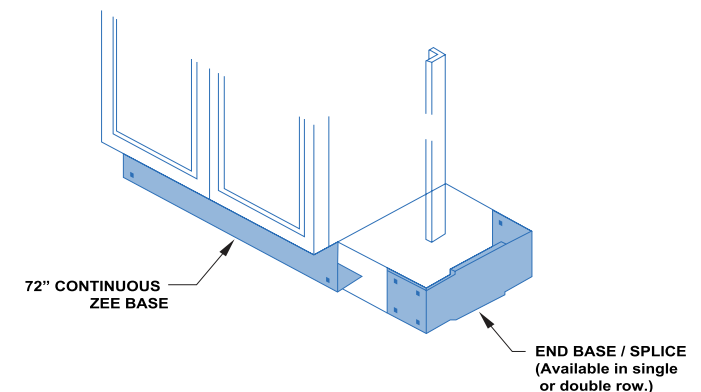

FILLERS.

Lockers Manufacturing provides standard fillers to adapt lockers to a wide range of field conditions and provide a professional, finish appearance. Fillers can be used to cover columns, pipes or other obstacles in a row of lockers, or fill the gap between the lockers and a wall.

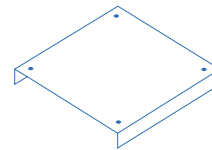
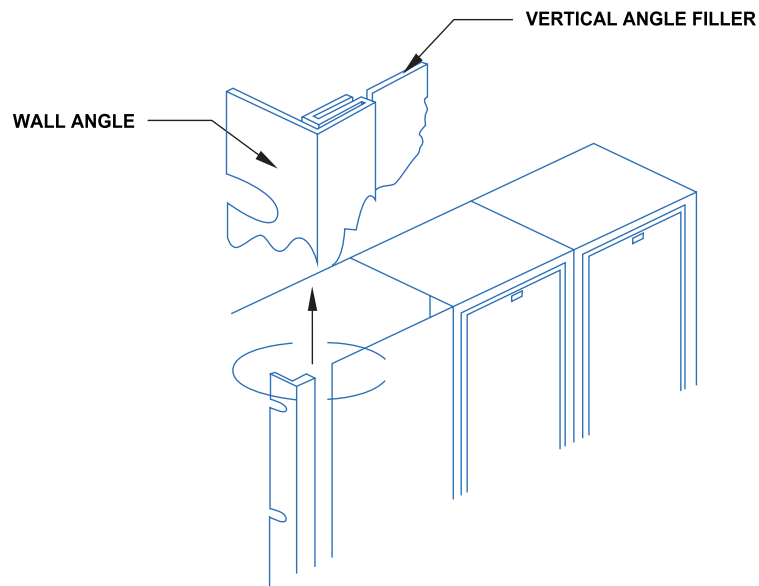

FLAT TOP FILLER

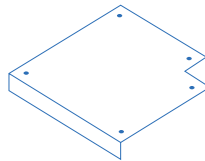

FLAT TOP CORNER FILLER

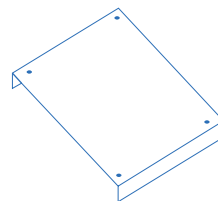

SLOPE TOP FILLER

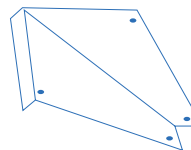

SLOPE TOP CORNER FILLER

VERTICAL FILLERS

They come in two widths and are designed to be used in conjunction with Wall Angle Slip Joints for a solid fit and smooth finish. The slip joint conceals any raw edges caused by field cutting.

TOP FILLERS

Top filler cover gaps between tops of lockers. They overlap the locker tops and can be field cut to allow for pipes, etc. There are separate designs for flat top vs. slope top, and in-line vs. corner applications.

Vertical Angle Fillers are available in the following widths and heights: 5x60, 5x72, 9x60, 9x72, 9x78, 12x60, 12x72 and 12x78.

Wall Angle Slip Joints are available in the following heights: 60, 72 and 78.

Flat Top Fillers are available in the following widths and depths: 15x12, 15x15 and 15x18.

Slope Top Fillers are available in the following widths and depths: 15x12, 15x15 and 15x18

Flat Top Corner Fillers are available in the following widths and depths: 12x12, 15x15 and 18x18

Slope Top Corner Fillers are available in the following widths and depths: 15x12, 15x15 and 15x18

BENCHES.

Elevating both comfort and organization, our locker benches seamlessly integrate into any floor plan. These benches provide the perfect blend of durability and aesthetic appeal. With painted or stainless steel pedestals for sturdy support, they are an essential addition to any locker room.

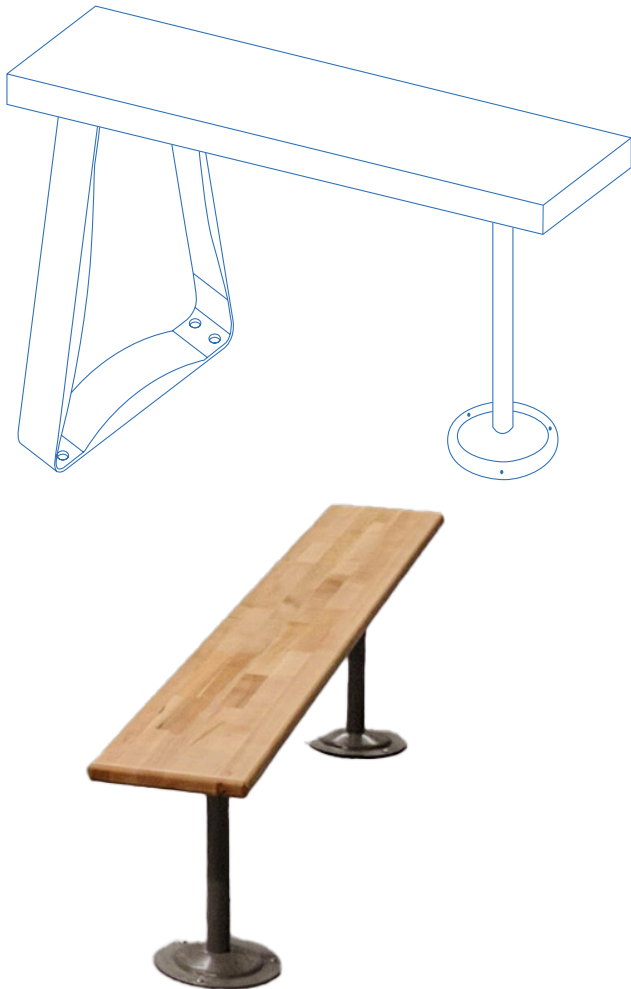

WOOD TOPS

Our solid butcher block bench seats, made of edge-grain maple, are coated with DURAKRYL 102®, a robust urethane-based finish resistant to sweat and stains. Standard bench tops measure 9-1/2" deep x 1-1/4" thick, while ADA-compliant options are available in depths of 12" or 24". Pedestals can be ordered separately for your convenience.

HDPE TOPS

Our HDPE bench tops measure 9-1/2" deep x 1-1/2" thick, while ADA-compliant options are available in depths of 12" or 24". Pedestals can be ordered separately for your convenience.

ALUMINUM TOPS

Our aluminum bench tops measure 9-1/2" deep x 1-1/4" thick, while ADA-compliant options are available in depths of 12" or 24". Pedestals can be ordered separately for your convenience.

STAINLESS STEEL TOPS

Our stainless steel bench tops measure 9-1/2" deep x 1-1/4" thick, while ADA-compliant options are available in depths of 12" or 24". Pedestals can be ordered separately for your convenience.

ADA OPTIONS

Benches that meet all ADA guidelines are AVAILABLE ADA BRACKETS DOUBLE REVERSED - contact a Lockers Manufacturing Representative for more information.

PEDESTALS.

Elevating both comfort and organization, our locker pedestals seamlessly integrate into any floor plan. With high-quality painted or stainless steel options, our pedestals provide sturdy support for our premium hardwood maple benches, making them an essential addition to any locker room.

Select from two distinct pedestal styles: the robust Heavy Duty Pedestal or the sleek Stainless Steel Pedestal. For benches measuring 96" long or less, opt for two pedestals; for those exceeding 96" in length, three pedestals are recommended. Specifically for the 48" x 24" ADA bench, four pedestals are required for optimal support and stability.

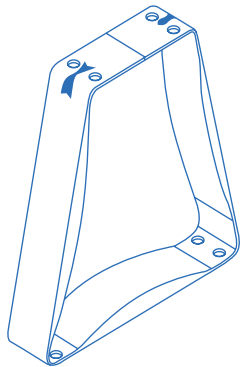

STAINLESS STEEL PEDESTAL

Featuring a 14" wide base, this pedestal offers versatility for freestanding use. Holes at the bottom enable optional floor anchoring or the attachment of non-skid bumpers (refer to the section below for details). Hardware is included for fastening to the bench top. *Stainless steel is typically not painted.

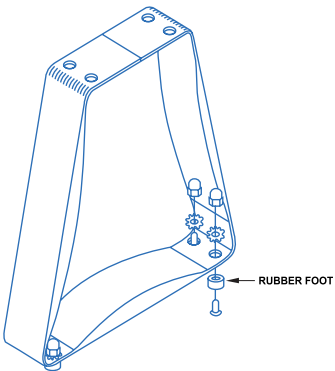

NON-SKID PEDESTAL KIT

Protect your floors with ease using rubber non-skid bumpers, designed to prevent damage. Each kit includes four non-marking rubber feet and the necessary fastening hardware. Ensure to order one kit per pedestal, exclusively for use with Stainless Steel Pedestals.

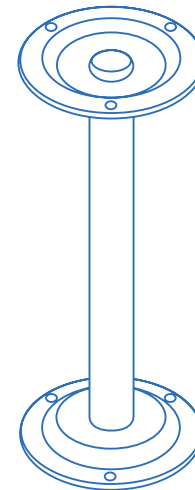

HEAVY DUTY PEDESTAL

Standing at a height of 16-1/4", this pedestal is constructed with a durable steel tube welded to top and bottom flanges, ensuring stability and strength. Hardware for securing to the bench is provided for your convenience, and floor anchoring is necessary for stability. Multiple pedestals are recommended per bench. Choose from all 24 available colors to complement your space effortlessly.

ADA OPTIONS

Benches that meet all ADA guidelines are AVAILABLE ADA BRACKETS DOUBLE REVERSED - contact a Lockers Manufacturing Representative for more information.

LOCKS.

Discover our range of locker ventilation options designed to promote airflow and maintain optimal conditions for stored items. From diamond-perforated doors and sides to louvers and vented backs, our ventilation solutions ensure proper air circulation, preventing moisture buildup and unpleasant odors. Choose the ventilation style that best suits your needs and create a fresh and hygienic environment within your locker spaces.



BUILT-IN KEY LOCK

Available in flat key or grooved key models. Deadbolt construction. ADA Compliant.



BUILT-IN COMBINATION LOCK

Master key controlled. Available with 5 combination changes for security year to year.



PORTABLE COMBINATION LOCK

Available with and without master keying. 3 number dialing. Rust resistant.



BLUETOOTH LOCK

Use your smartphone to open and manage your lock with the Master Lock® Vault System. Compatible with Master Lock Vault Home and Master Lock Vault Enterprise, it offers:

- Free apps for iOS and Android
- Monitor access history
- Locker Mode for secure storage
- Ideal for personal or business use
- No keys or combinations
- Backup access with directional code
- Low battery notification
- Easy CR2450 battery replacement



DIGI LOCK

Can be locked with any 4 digit code. Electronic bypass key. Tamper guard. Usage indicator.

SEAT CUSHION.

Explore our cushion options designed to provide comfort and support. Choose the single bottom cushion for a sleek and minimalist design, ideal for short periods of sitting. Opt for the bottom and back cushion for added lumbar support, perfect for longer durations. Available in multiple colors, our cushions enhance the usability and comfort of your locker spaces.

BOX STYLE CONSTRUCTION (BOTTOM ONLY)

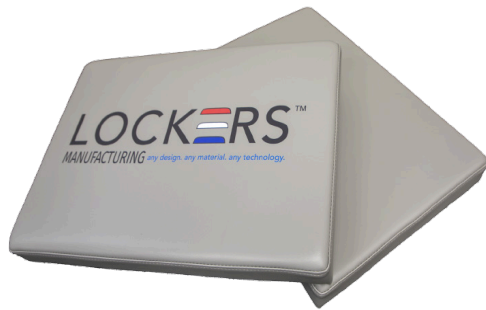

- Same height boxing around cushion
- 1" to 3" foam
- 1/2" or 3/4" plywood
- Velcro fasteners attached
- Monogram option available
- T-Nuts can be installed with customer provided CAD drawing
- 100% customizable to fit your specifications
- Multiple color options available (*can match almost any PanTone Color; contact a sales rep for more info*)

BOX STYLE CONSTRUCTION (BACK & BOTTOM)

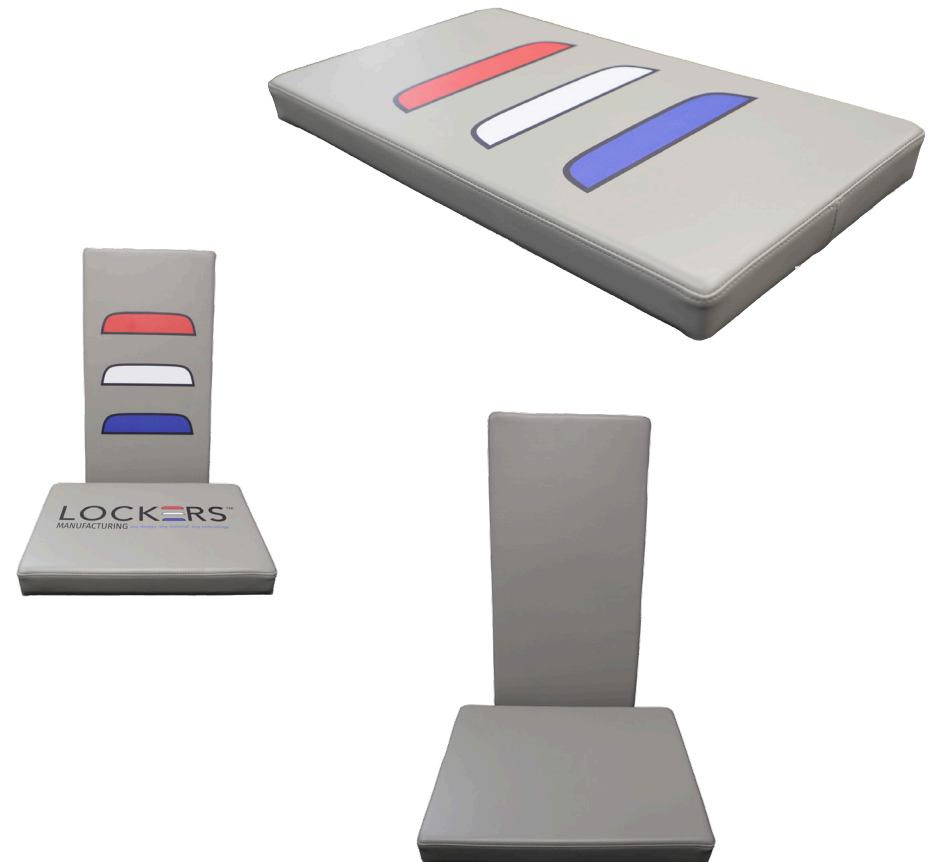

ARMORSTACK.

Introducing the ArmorStack, designed to maximize organization and efficiency in locker spaces. This innovative rack provides dedicated storage for helmets and shoulder pads, keeping essential gear neatly organized and easily accessible. With its durable construction and space-saving design, the ArmorStack ensures that players can quickly grab their equipment and focus on the game. Simplify your locker room setup and elevate your team's performance with the ArmorStack.



HELMET AND SHOULDER PAD RACK

- Three or four grade stainless Steel
- 14.5"W x 18.25"H
- 23 degree front angle
- Tubular design
- Field installation
- Installation hardware provided
- Customization available for different size
- Metal, Wood, HDPE available

**LOCKERS
MANUFACTURING**

BUSINESS DEVELOPMENT.

2014

RELOCATED TO
BATESVILLE, MS

\$31.2M

IN ECONOMIC IMPACT
GROWING TO

97

JOBS SUPPORTED & SUSTAINED
GROWING TO

\$1.6M

LOCAL, STATE & FEDERAL TAX IMPACT
GROWING TO

2024

GROUND BREAKING
BUILDING EXPANSION

\$345.4M

IN 10 YEARS

664 JOBS

IN 10 YEARS

\$13.5M

IN 10 YEARS



**“GREAT THINGS IN BUSINESS ARE
NEVER DONE BY ONE PERSON;
THEY’RE DONE BY A TEAM OF PEOPLE.”**



We would love for you to check out our brief economic impact report. Scan the QR code to view it now.

KEY OF SUCCESS.

“SUCCESS IS CRAFTED THROUGH UNWAVERING DETERMINATION, RELENTLESS INNOVATION, COLLABORATIVE SYNERGY, AND THE ABILITY TO ADAPT AND THRIVE IN THE FACE OF CHANGE.”

At Lockers Manufacturing, our commitment to success is built on the foundations of determination, innovation, collaboration, and adaptability. These keys to success drive us to deliver exceptional storage solutions, continually improve our products, and foster a collaborative environment where our team and clients thrive together. By embracing these principles, we ensure the highest standards of quality and customer satisfaction.



DETERMINATION

Maintain unwavering commitment to our goals, pushing through challenges and setbacks with resilience and perseverance.



INNOVATION

Embrace new ideas and technologies, continuously seeking ways to improve processes and create value.



COLLABORATION

Foster effective teamwork by leveraging the diverse skills, knowledge, and perspectives of others to achieve common objectives.



ADAPTABILITY

Stay flexible and responsive to change, turning obstacles into opportunities for growth and advancement.

LOCKERS™

MANUFACTURING any design. any material. any technology.

THANK YOU
FOR YOUR BUSINESS

2025

P : 662-338-4340

M : sales@lockersmfg.com

A : P.O. Box 208 Como, MS 38619